

140

143

144

144

138

145

142

144

143

146

PreDes Bremen



(C) PreDes 2009

019

*only for
streetpaper.de*

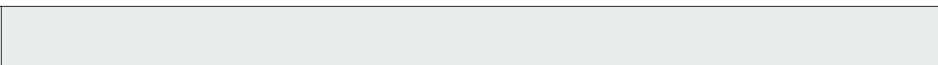
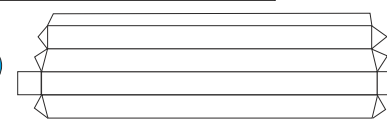
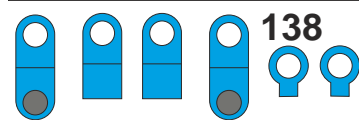
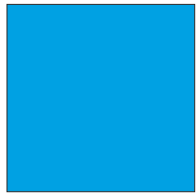
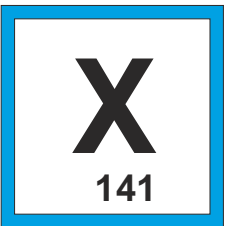
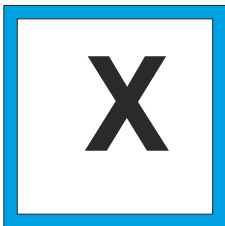

148

149

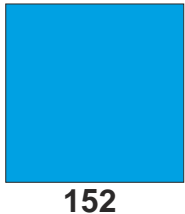
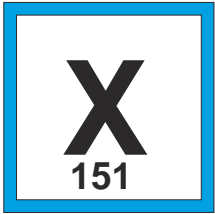

153

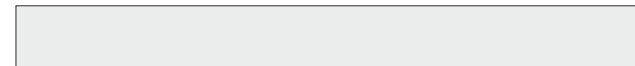

138

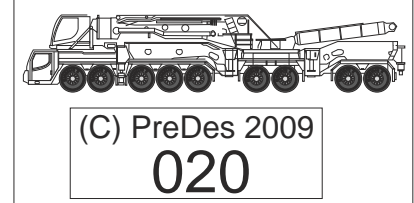
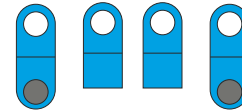

150

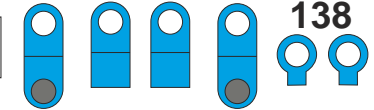

138

150

149

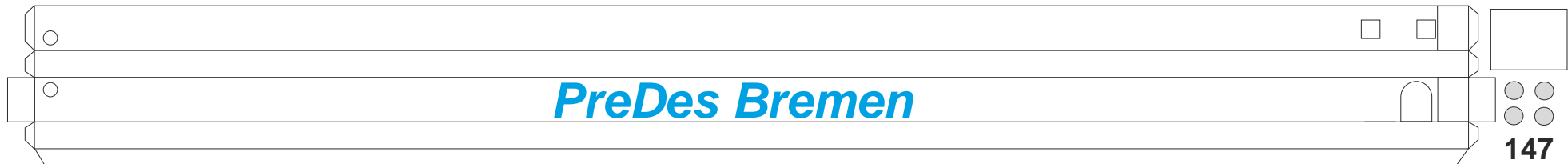

147

only for
streetpaper.de

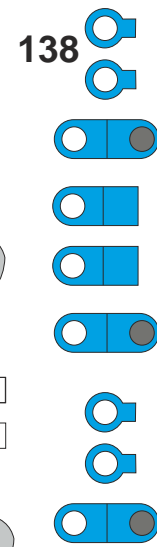
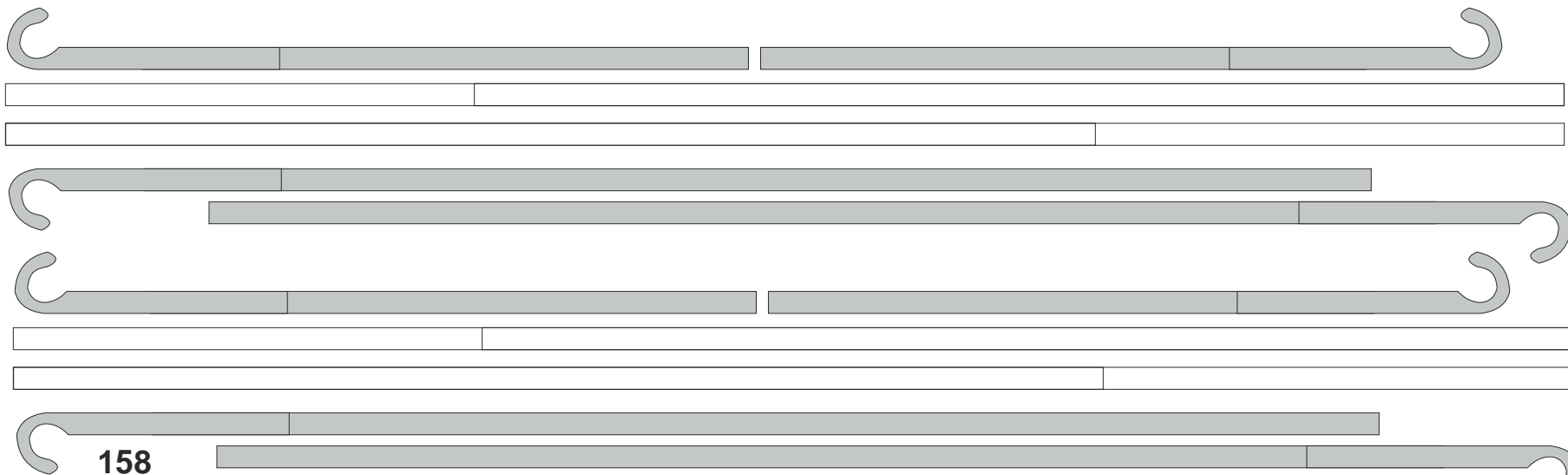

138



158

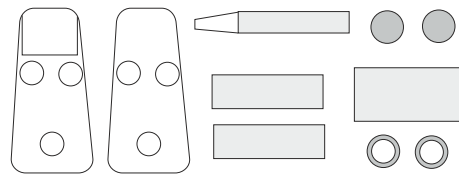

160

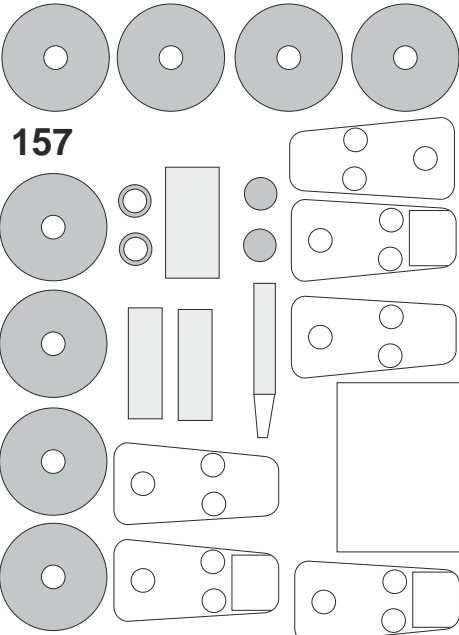

157

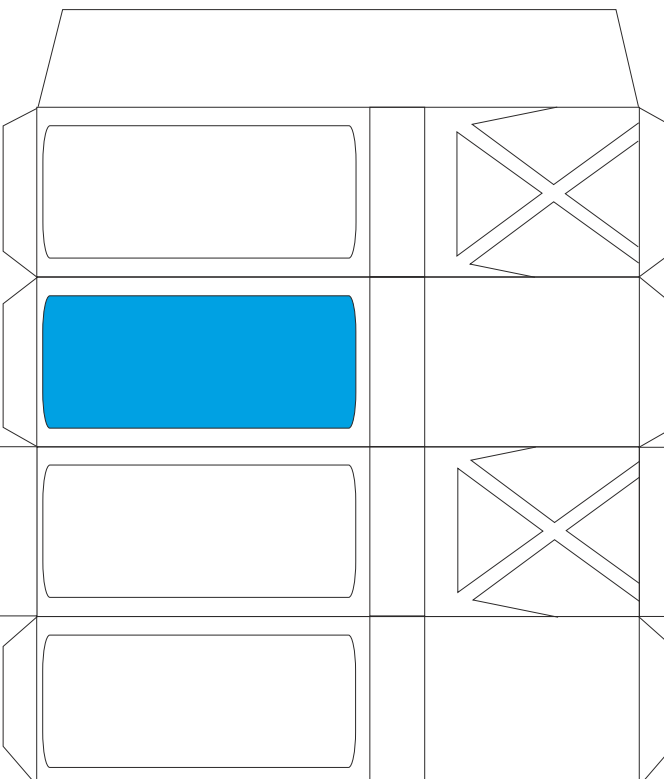

154

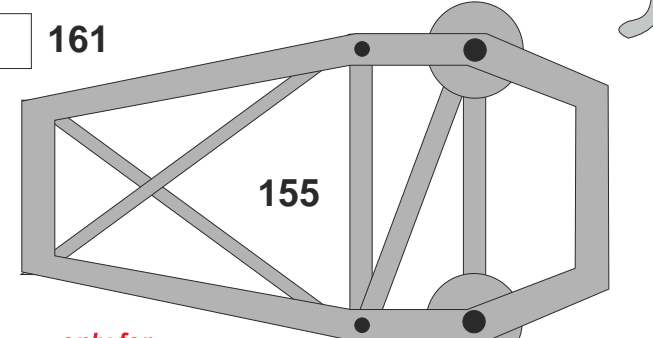

155

only for streetpaper.de

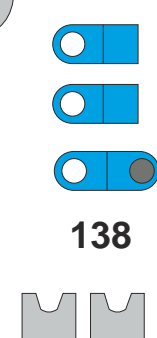
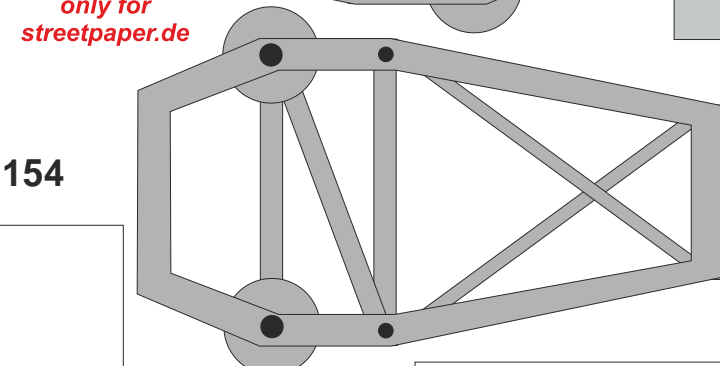

138

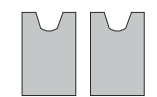

159



156

159



159

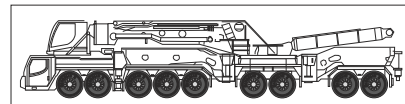

(C) PreDes 2009

021

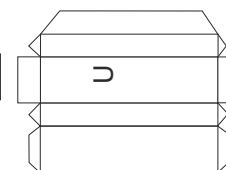
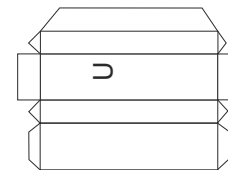
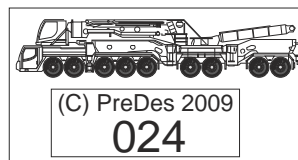
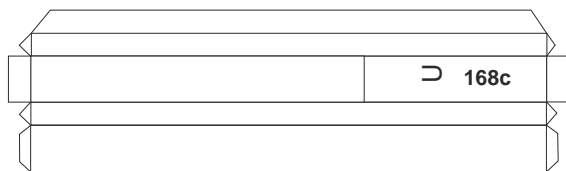
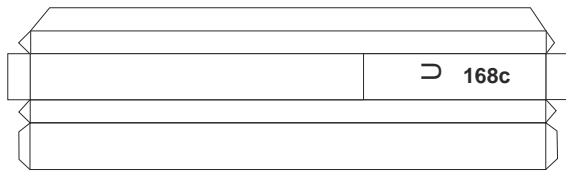

167

167

167d

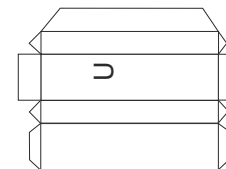
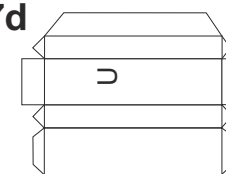
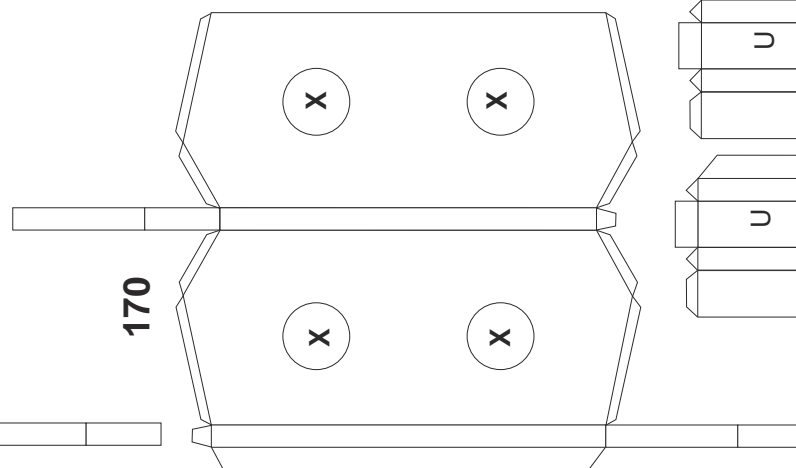
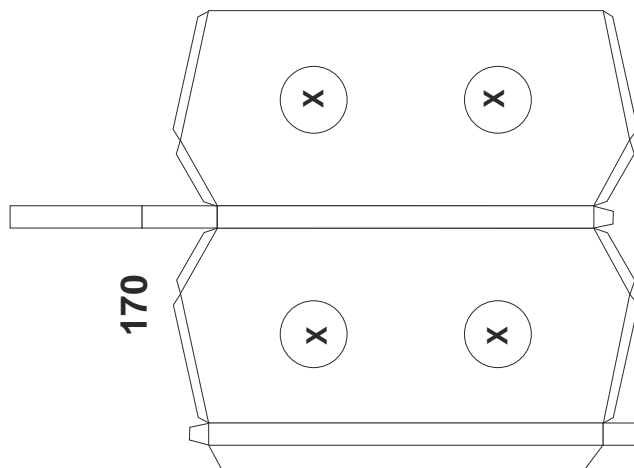
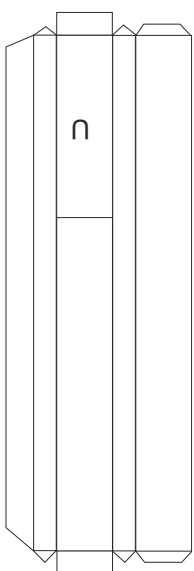
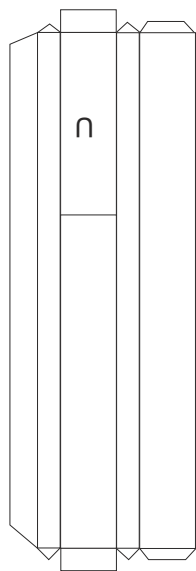

*only for
streetpaper.de*

