

© 04/2005  
v.preikschat@t-online.de  
[www.streetpaper.de](http://www.streetpaper.de)  
PreDes - Bremen

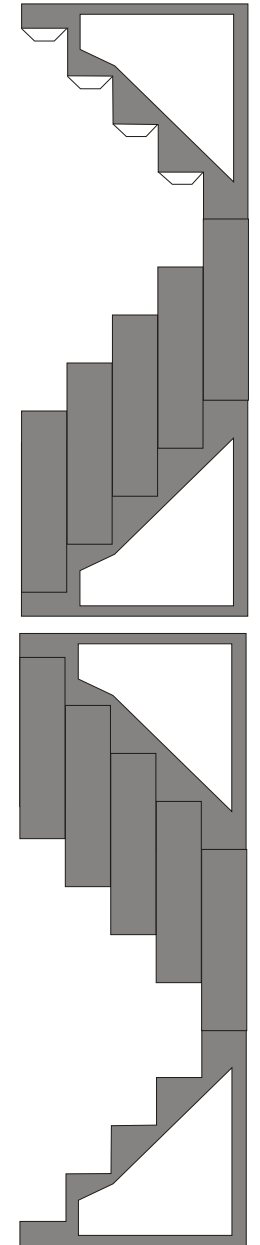

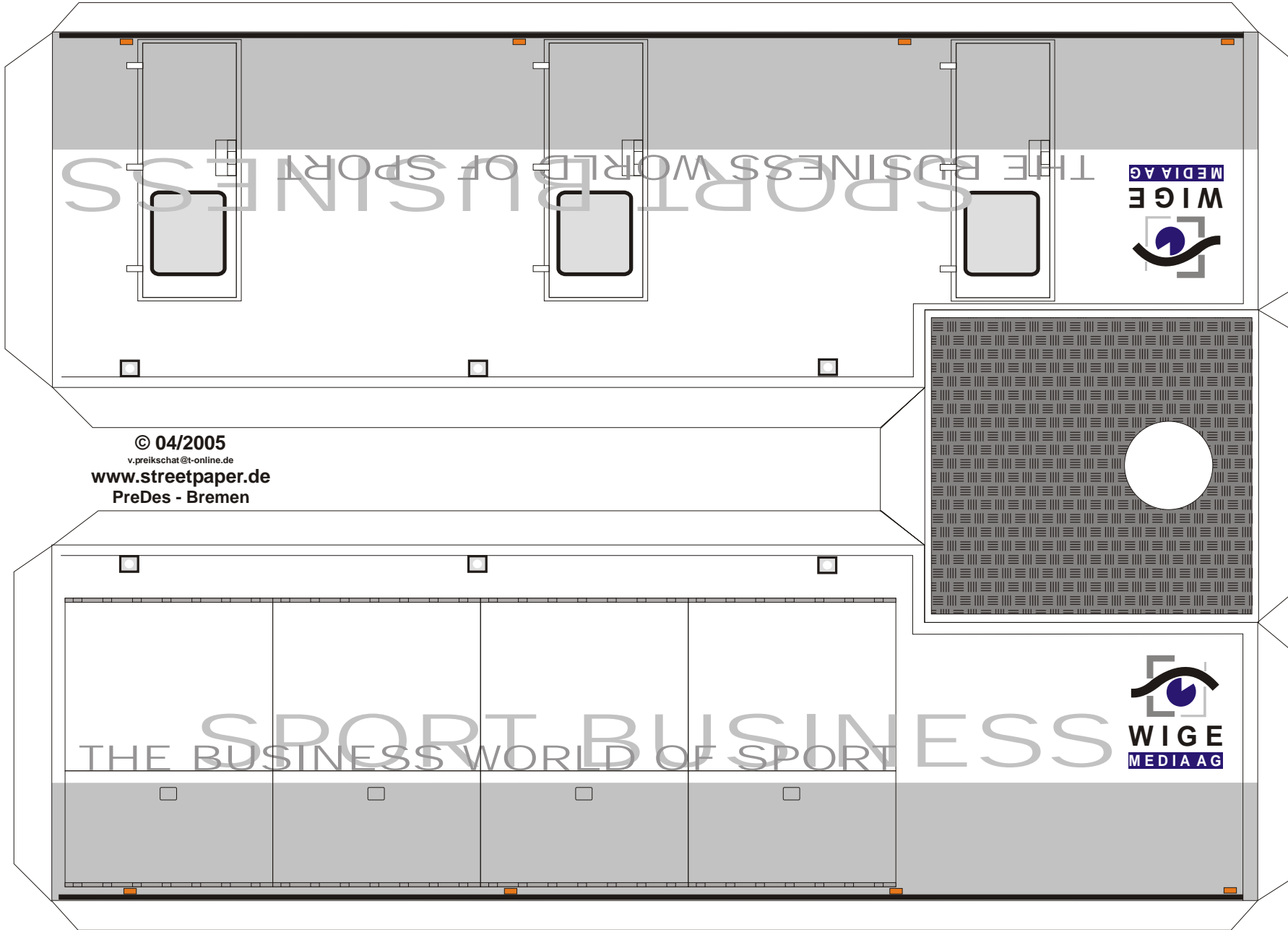

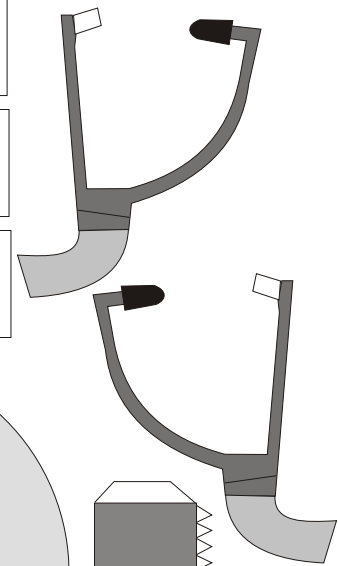
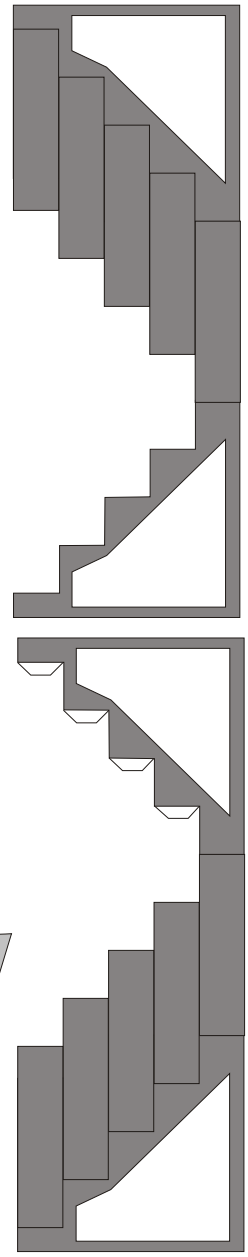
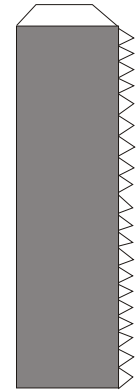
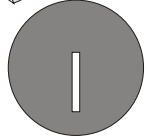
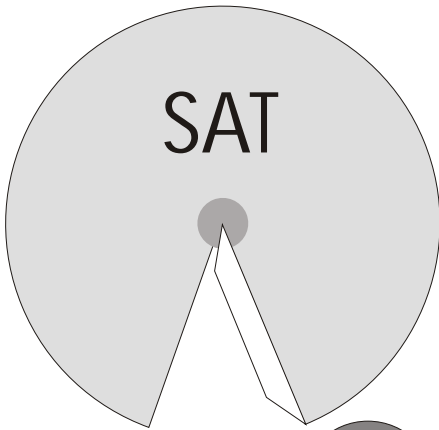
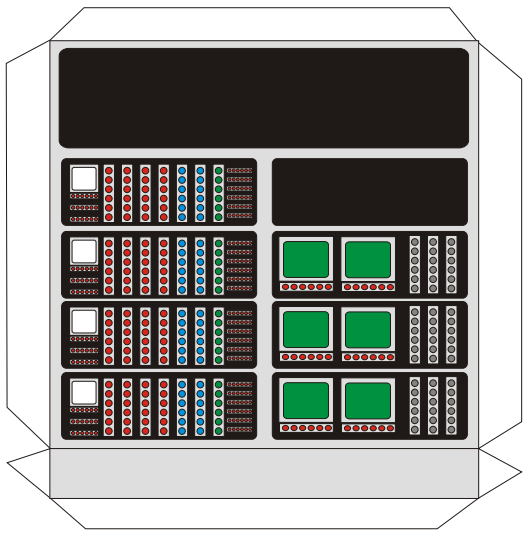
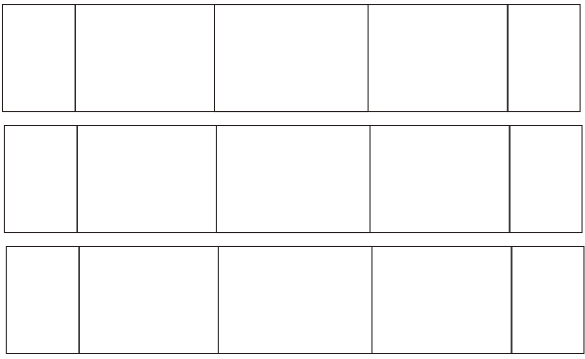
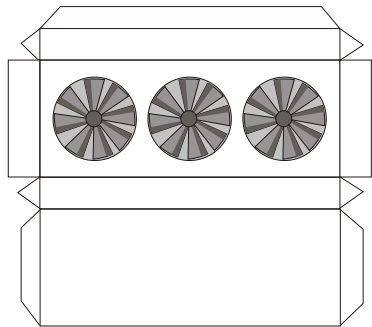
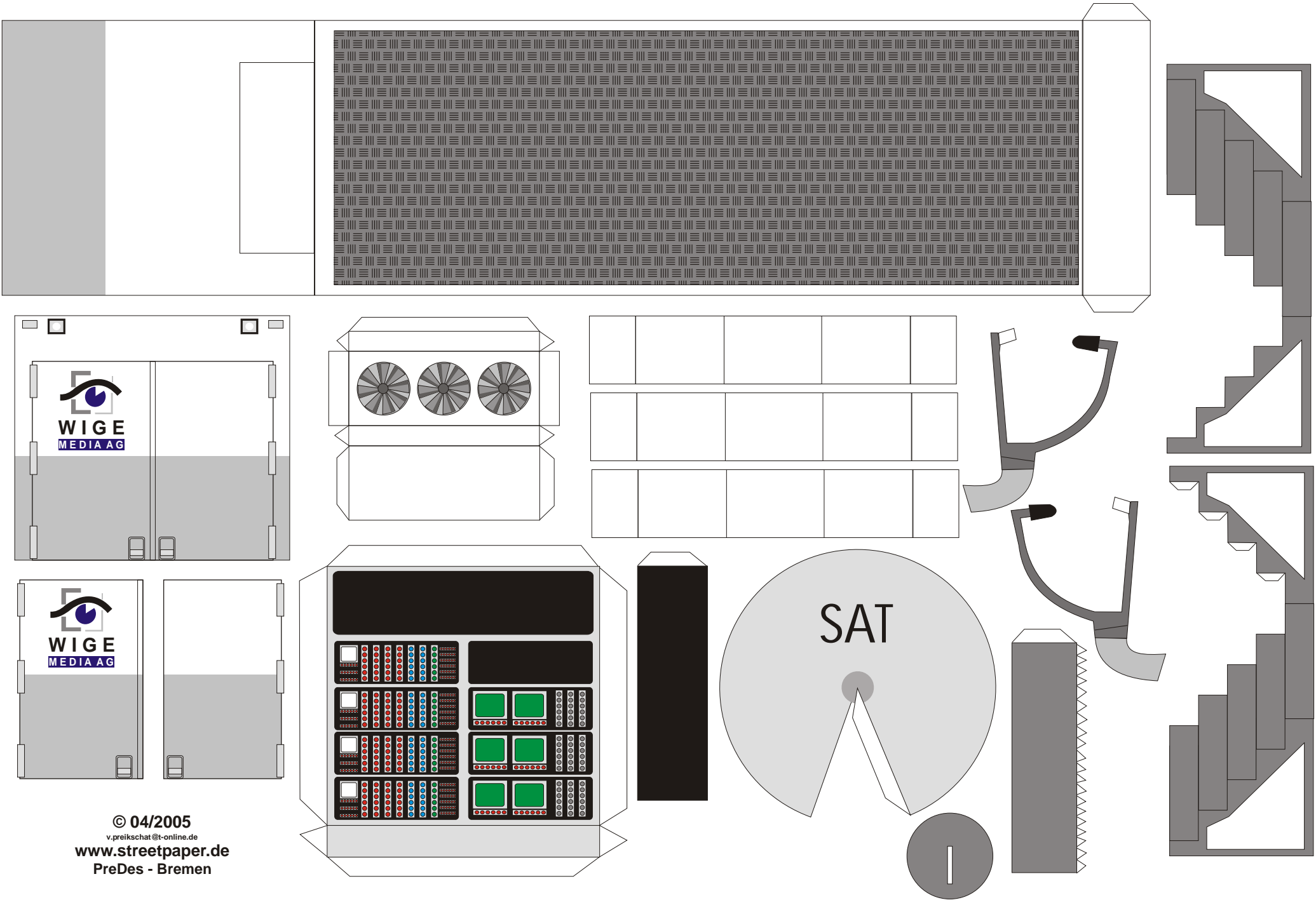
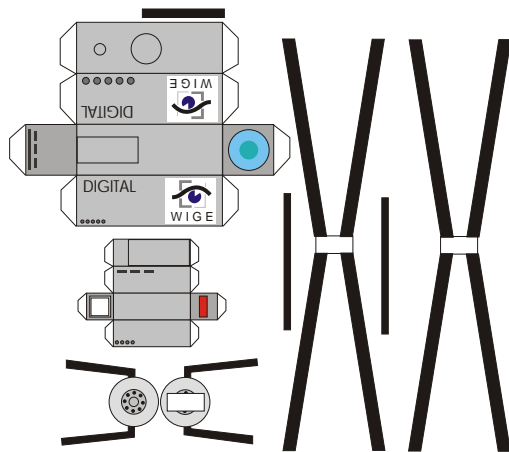
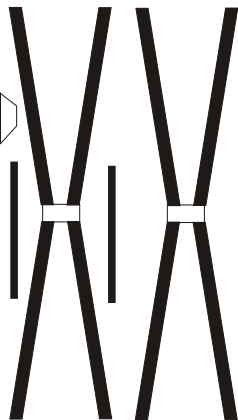
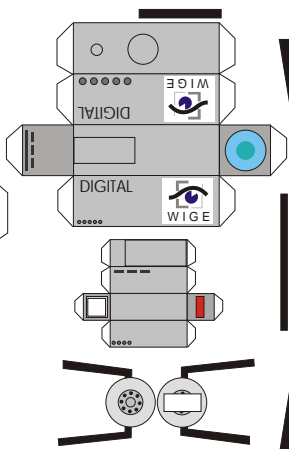
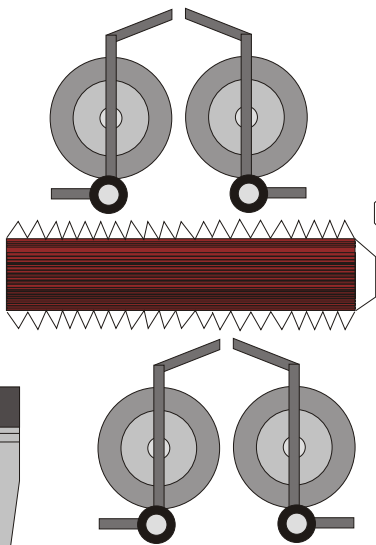
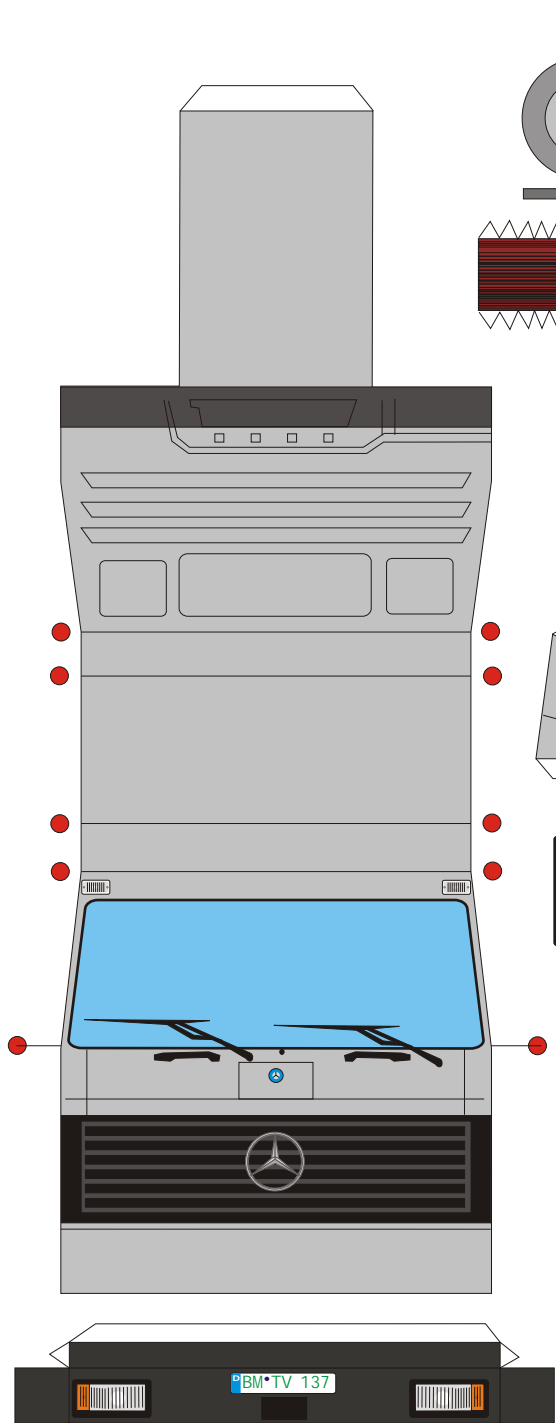

© 04/2005  
v.preikschat@t-online.de  
[www.streetpaper.de](http://www.streetpaper.de)  
PreDes - Bremen

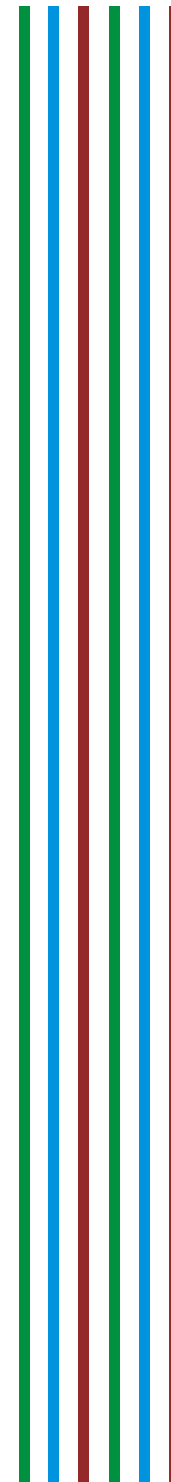
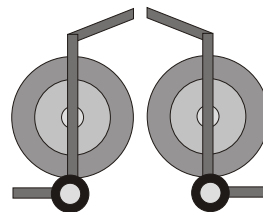
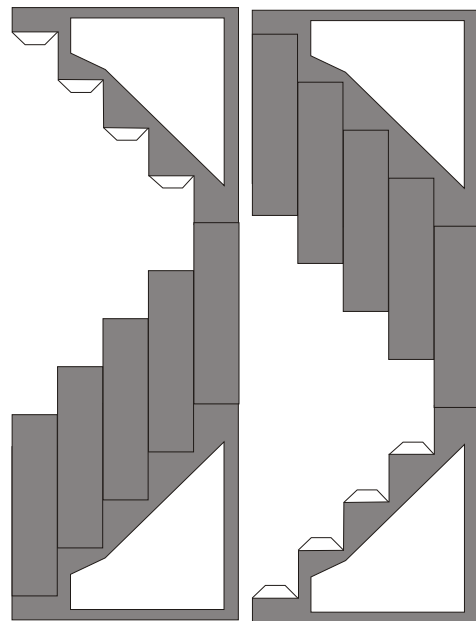
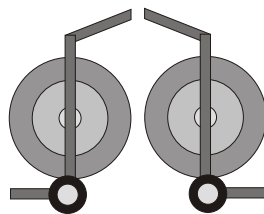
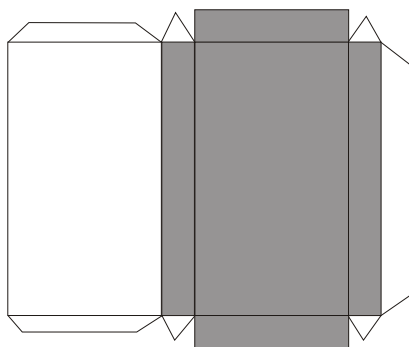

# Übertragungseinheit SAT

© 04/2005  
v.preikschat@t-online.de  
www.streetpaper.de  
PreDes - Bremen

© 04/2005  
v.preikschat@t-online.de  
www.streetpaper.de  
PreDes - Bremen

